

# Analog Devices Welcomes Hittite Microwave Corporation

NO CONTENT ON THE ATTACHED DOCUMENT HAS CHANGED

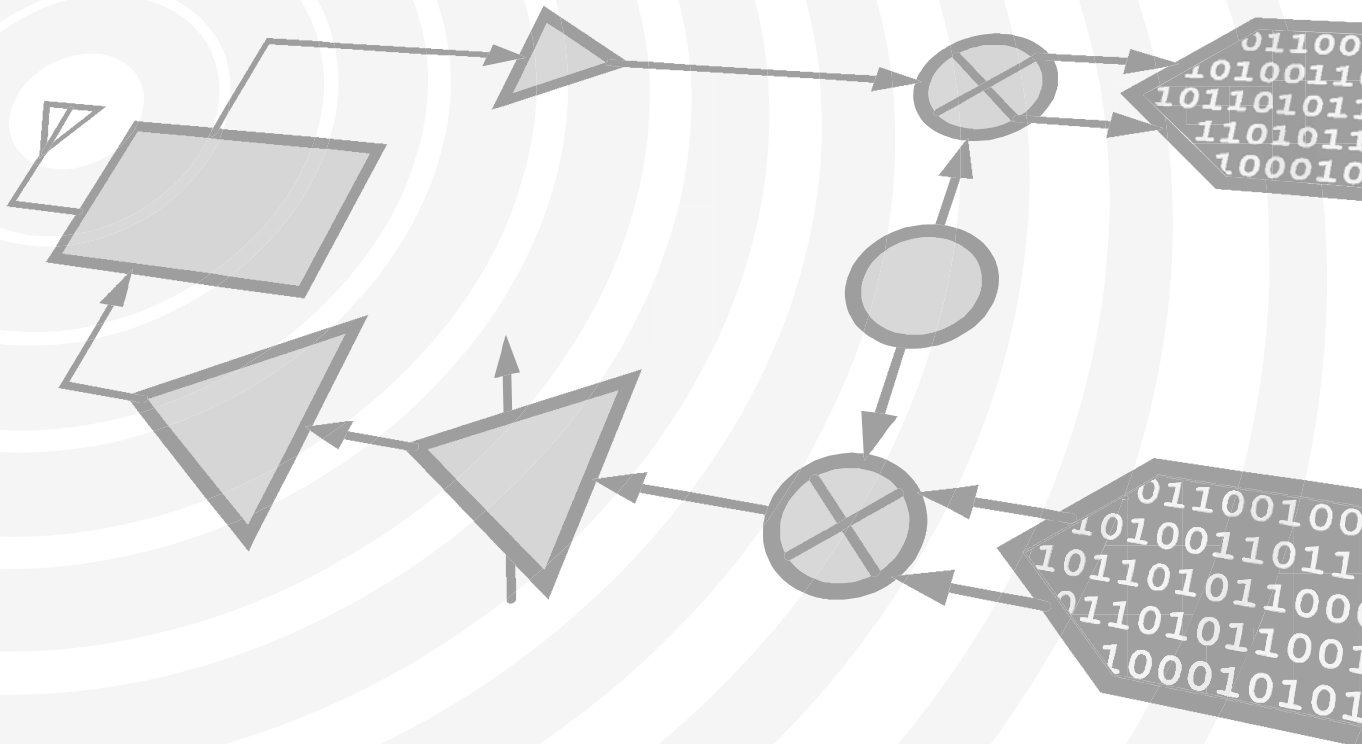

**THIS PAGE INTENTIONALLY LEFT BLANK**



## SMT GaAs HBT MMIC x4 ACTIVE FREQUENCY MULTIPLIER 11.4 - 13.2 GHz OUTPUT

### Typical Applications

The HMC695LP4(E) is ideal for:

- Fiber Optic Applications
- Point-to-Point Radios
- Military Radar

### Features

- Output Power: +7 dBm
- Sub-Harmonic Suppression: >25 dBc
- SSB Phase Noise: -140 dBc/Hz
- Single Supply: +5V @ 60 mA
- 24 Lead 4x4 mm SMT Package: 16 mm<sup>2</sup>

### Functional Diagram

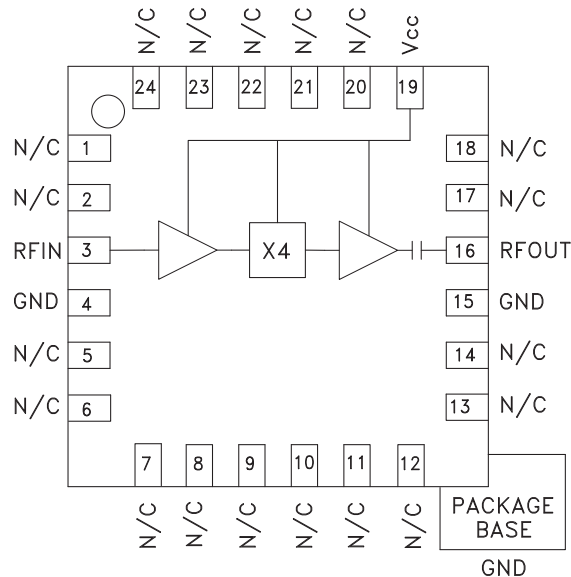

### General Description

The HMC695LP4(E) are active miniature x4 frequency multipliers utilizing InGaP GaAs HBT technology in 4x4 mm leadless surface mount packages. Power output is +7 dBm typical from a +5V supply voltage and varies little vs. input power, temperature and supply voltage. Suppression of undesired fundamental and sub-harmonics is >25 dBc typical with respect to output signal level. The low additive SSB phase noise of -140 dBc/Hz at 100 kHz offset helps the user maintain good system noise performance. The HMC695LP4(E) are ideal for use in LO multiplier chains allowing reduced parts count vs. traditional approaches.

### Electrical Specifications, $T_A = +25^\circ \text{C}$ , $V_{CC} = 5V$

| Parameter                        | Min.        | Typ. | Max. | Units  |
|----------------------------------|-------------|------|------|--------|
| Frequency Range, Input           | 2.85 - 3.3  |      |      | GHz    |
| Frequency Range, Output          | 11.4 - 13.2 |      |      | GHz    |
| Input Power Range                | -15         |      | 5    | dBm    |
| Output Power                     | 2           | 7    |      | dBm    |
| Sub-Harmonic Suppression         |             | 25   |      | dBc    |
| Input Return Loss                |             | 15   |      | dB     |
| Output Return Loss               |             | 8    |      | dB     |
| SSB Phase Noise (100 kHz Offset) | Pin= 0 dBm  | -140 |      | dBc/Hz |
| Supply Current (Icc)             |             | 60   | 75   | mA     |

# HMC695LP4 / HMC695LP4E

## SMT GaAs HBT MMIC x4 ACTIVE FREQUENCY MULTIPLIER

### 11.4 - 13.2 GHz OUTPUT

**Output Power vs. Temperature @ -10 dBm Drive Level**

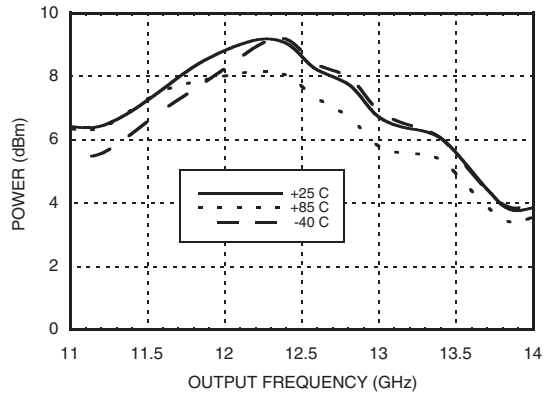

**Output Power vs. Drive Level**

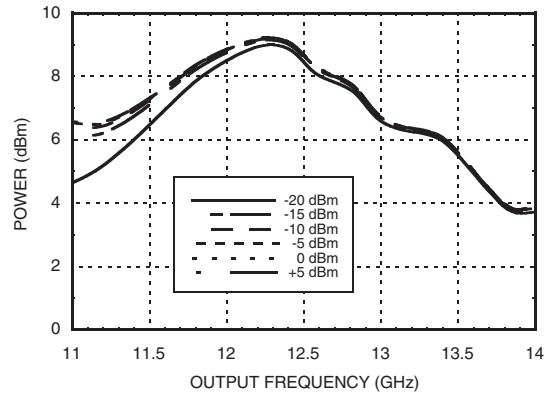

**Output Power vs. Supply Voltage @ -10 dBm Drive Level**

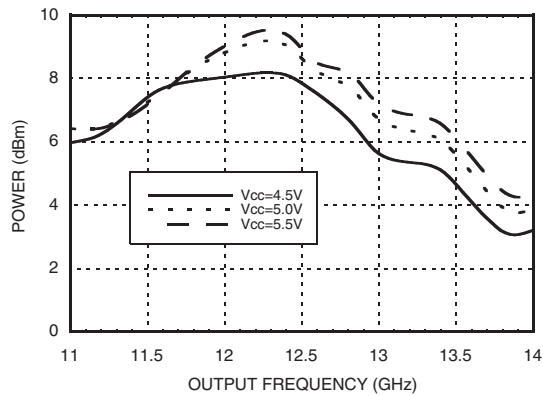

**Input Return Loss vs. Temperature**

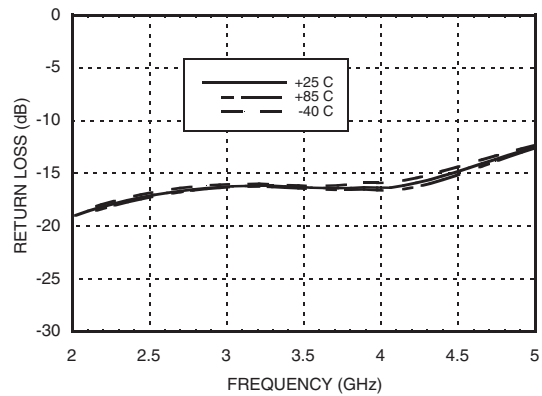

**Output Return Loss vs. Temperature**

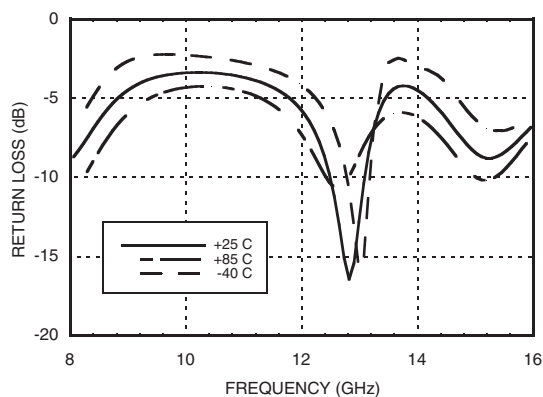

**Harmonics @ -10 dBm Drive Level**

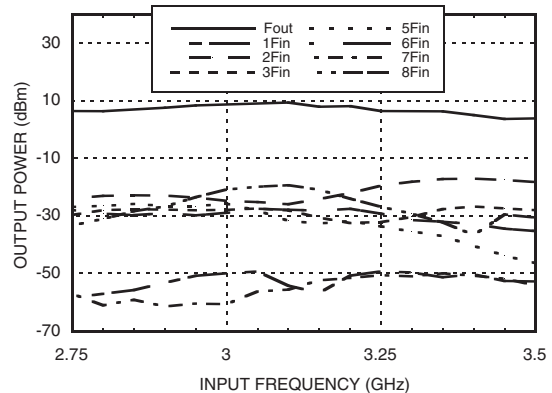

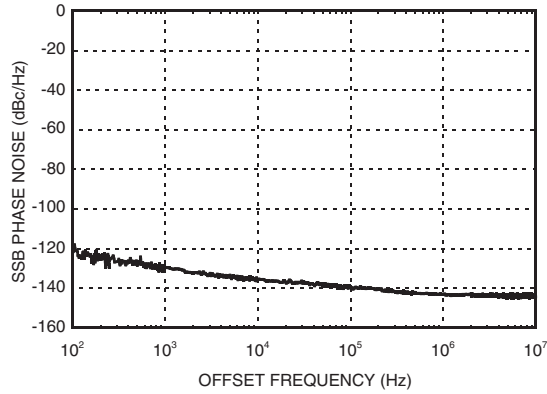
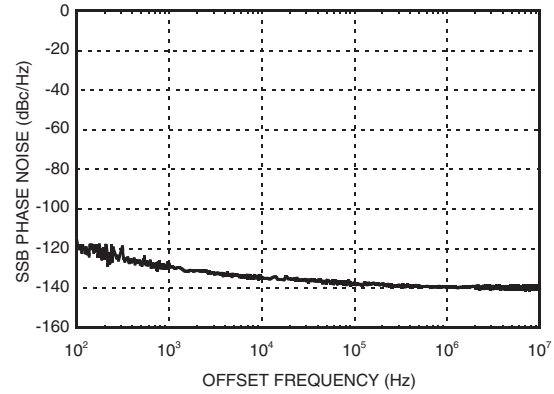
**SMT GaAs HBT MMIC x4 ACTIVE FREQUENCY MULTIPLIER  
11.4 - 13.2 GHz OUTPUT**
**SSB Phase Noise**
**@ Pin = 0 dBm @ 12.5 GHz**

**SSB Phase Noise**
**@ Pin = -10 dBm @ 12.5 GHz**

**Absolute Maximum Ratings**

|   |                |
|---|----------------|
| RF Input (Vcc= +5V)   | +20 dBm        |
| Vcc   | +5.5V          |
| Channel Temperature   | 135 °C         |
| Continuous P <sub>diss</sub> (T=85 °C)<br>(derate 10.8 mW/°C above 85 °C) | 538 mW         |
| Thermal Resistance (R <sub>thj</sub> )<br>(junction to ground paddle)     | 93 °C/W        |
| Storage Temperature   | -65 to +150 °C |
| Operating Temperature   | -40 to +85 °C  |
| ESD Sensitivity (HBM)   | Class 1B       |

**Typical Supply Current vs. Vcc**

| Vcc (V) | I <sub>cc</sub> (mA) |
|---------|----------------------|
| 4.75    | 59                   |
| 5.00    | 60                   |
| 5.25    | 61                   |

Note: Multiplier will operate over full voltage range shown above.



**ELECTROSTATIC SENSITIVE DEVICE  
OBSERVE HANDLING PRECAUTIONS**

### Outline Drawing

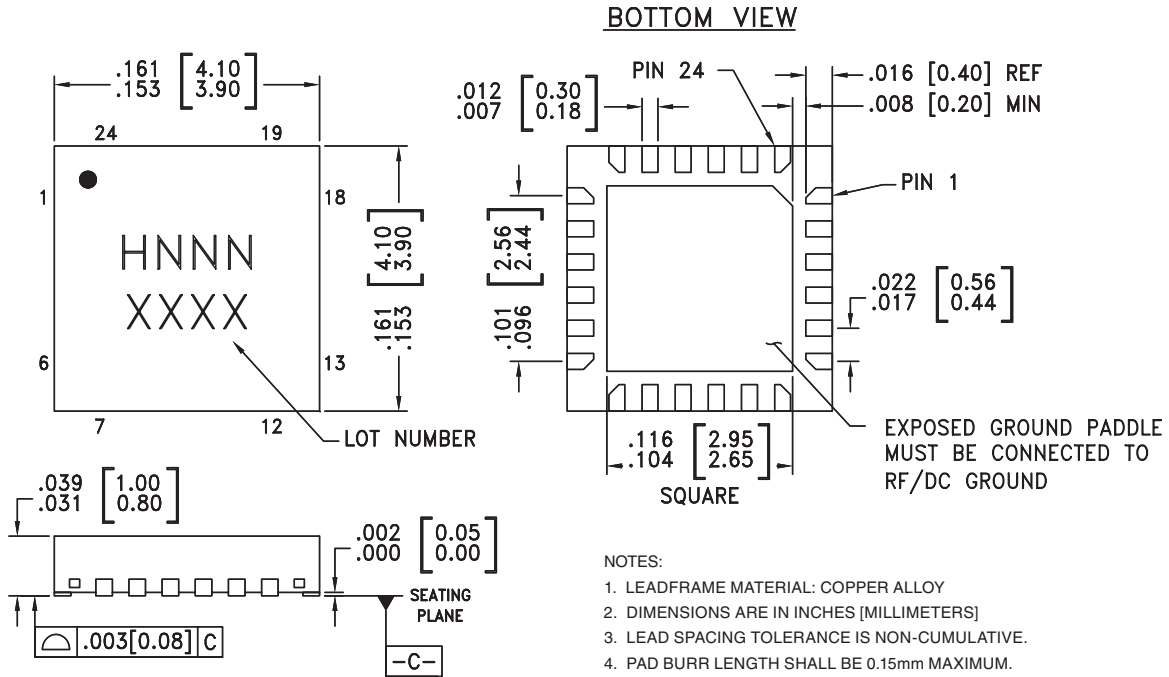

- NOTES:
1. LEADFRAME MATERIAL: COPPER ALLOY
  2. DIMENSIONS ARE IN INCHES [MILLIMETERS]
  3. LEAD SPACING TOLERANCE IS NON-CUMULATIVE.
  4. PAD BURR LENGTH SHALL BE 0.15mm MAXIMUM.  
PAD BURR HEIGHT SHALL BE 0.05mm MAXIMUM.
  5. PACKAGE WARP SHALL NOT EXCEED 0.05mm.
  6. ALL GROUND LEADS AND GROUND PADDLE MUST BE SOLDERED TO PCB RF GROUND.
  7. REFER TO HITTITE APPLICATION NOTE FOR SUGGESTED LAND PATTERN.



### Package Information

| Part Number | Package Body Material                              | Lead Finish   | MSL Rating          | Package Marking <sup>[3]</sup> |
|-------------|--|---------------|---------------------|--------------------------------|
| HMC695LP4   | Low Stress Injection Molded Plastic                | Sn/Pb Solder  | MSL1 <sup>[1]</sup> | H695<br>XXXX                   |
| HMC695LP4E  | RoHS-compliant Low Stress Injection Molded Plastic | 100% matte Sn | MSL1 <sup>[2]</sup> | H695<br>XXXX                   |

[1] Max peak reflow temperature of 235 °C  
 [2] Max peak reflow temperature of 260 °C

[3] 4-Digit lot number XXXX

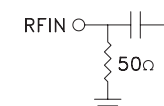
**SMT GaAs HBT MMIC x4 ACTIVE FREQUENCY MULTIPLIER**  
**11.4 - 13.2 GHz OUTPUT**
**Pin Description**

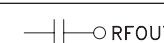
| Pin Number                       | Function | Description  | Interface Schematic   |
|----------------------------------|----------|--|---|
| 1, 2, 5 - 14,<br>17, 18, 20 - 24 | N/C      | The pins are not connected internally; however, all data shown herein was measured with these pins connected to RF/DC ground externally. |   |
| 3                                | RFIN     | RF input needs to be DC blocked only if there is an external DC voltage applied to RFIN.   |  |
| 4, 15                            | GND      | All ground leads and ground paddle must be soldered to PCB RF/DC ground.   |  |
| 16                               | RFOUT    | Multiplied Output. AC coupled. No external DC blocks necessary.  |  |
| 19                               | Vcc      | Supply voltage 5V  |   |

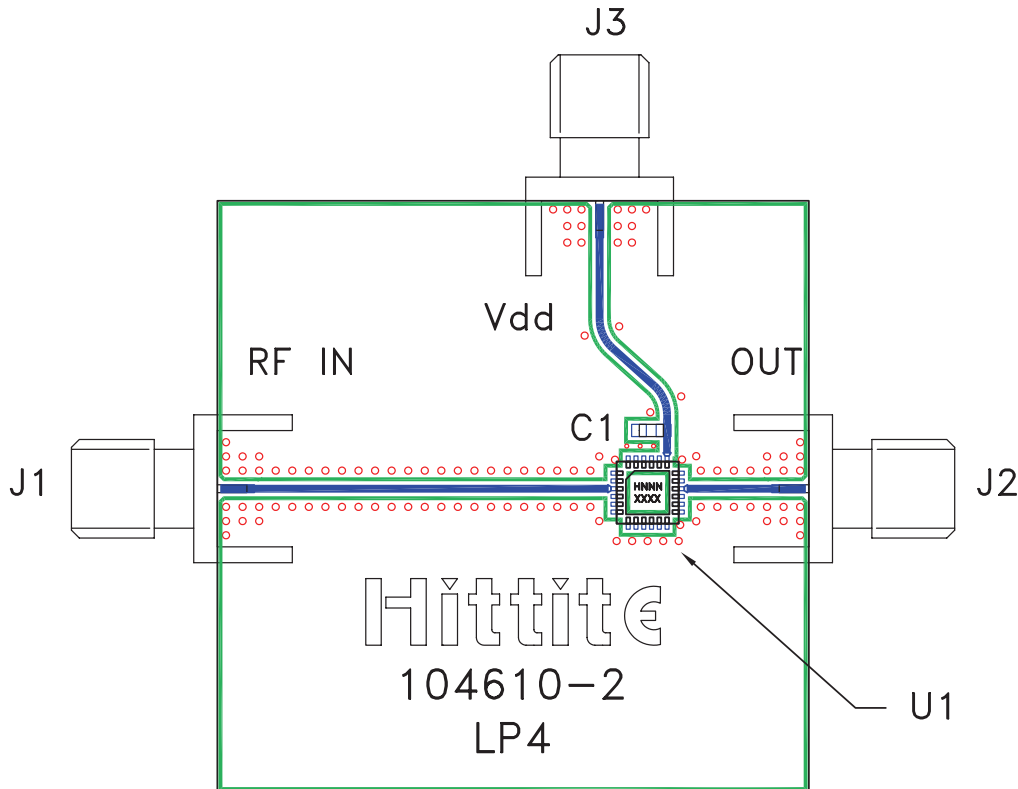
**Evaluation PCB**

**List of Materials for Evaluation PCB 106137 [1]**

| Item    | Description                       |
|---------|-----------------------------------|
| J1 - J3 | PCB Mount SMA Connector           |
| C1      | 1,000 pF Capacitor, 0603 Pkg.     |
| U1      | HMC695LP4(E) x4 Active Multiplier |
| PCB [2] | 104610 Eval Board                 |

[1] Reference this number when ordering complete evaluation PCB

[2] Circuit Board Material: Arlon 25FR or Rogers 4350

The circuit board used in the application should be generated with proper RF circuit design techniques. Signal lines should have 50 ohm impedance while the package ground leads and exposed paddle should be connected directly to the ground plane similar to that shown. The evaluation circuit board shown is available from Hittite upon request.